

Product Type : P10 RGB Module

Product Code : P10RGB-OSAB1S-3216

Content

Introduction	P.3
Application	
Feature	
Product Characterize	P.4
Recommended Rating	
Absolute Rating	
Electrical Characterize	
Reliability	
Block Diagram	P.6
Interface Connection	P.7
Power pin Assignment	
Connection pin Assignment	
Pin Function Description	
Driver IC Terminal Configuration	P.8
Switching Characterize	P.9
Timing Waveform	
Timing Chart	
LED Mapping	
Shift Register Mapping	
Module dimension	P.13
Important Notice	P.14
Revision History	P.17

Introduction

SDM-P10RGB-OSAB1Q-3216 is a 32×16 full color SMD LED unit design for wide range of applications such as video screens, graphic, alphabet, numeric, symbol and VMS without color distribution.

Applications

- Full Color Video Screen
- Outdoor Concert & Performance Screen
- Stadium Display
- Advertising Display
- Sport Parameter Screen

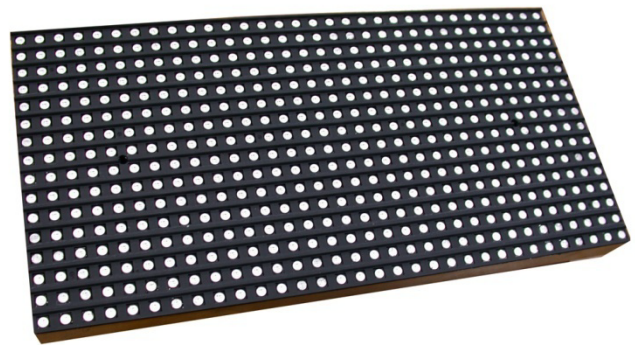

Features

Module Type	Outdoor LED Display Module
LED Type	3-in-1 SMD
Display Color	Red, Green, Blue
Module dimension	320mm x 160mm
Module Pixel	512 pixel / module
Pixel Pitch	10mm
Resolution	10000dot / m ²
Brightness (Typ.)	8000nit
Gray Scale	4096 Level for each color
Weight (Typ.)	1000g / Module

Product Characterize

Recommended Rating (Ta = 25°C)

Item	Symbol	Value	Unit
Control Circuit Voltage	VCC	5.0 ± 0.2	DC V
LED Voltage	VLED1	2.0 ± 0.2	DC V
	VLED2	3.2 ± 0.2	DC V
Activity Temperature	Topr	0 ~ 45	°C

Absolute Rating (Ta = 25°C)

Item	Symbol	Value	Unit
Supply Voltage	VIN	-0.3 ~ VCC+0.3	DC V
Control Circuit Voltage	VCC	- 0.3 ~ 5.2	DC V
LED Voltage	VLED1	- 0.3 ~ 2.4	DC V
	VLED2	- 0.3 ~ 3.6	DC V
Activity Temperature	Topr	- 10 ~ 60	°C
Storage Temperature	Tstg	- 20 ~ 85	°C

Electrical / Luminance Characterize

Luminance (Typ.)	Red	2400	mcd
	Green	4800	mcd
	Blue	800	mcd
	White	8000	mcd
Wavelength	Red	625 ± 5	nm
	Green	525 ± 5	nm
	Blue	470 ± 5	nm
Gray Scale	4096 Gray Scale for Each color		
Current Usage (Typ.)	Icc	12	A (DC 5V)
Viewing Angle (Typ.)	Horizontal Axis	120	Degree
	Vertical Axis	120	Degree

*Luminance Tolerance : 15% for each color

Product Characterize

Reliability Test (with recommend rating)

Test		Test condition	Note	Amount	Error
Activity Test	Room Temperature	25°C	1000 hr	2	0
	Low Temperature	-10°C	1000 hr	2	0
	High Humidity Heat	60°C / RH=90%	1000 hr	2	0
	Thermal cycle	-10°C ~ 60°C	250 cycle	2	0
Storage Test	Room Temperature	25°C	1000 hr	1	0
	Low Temperature	-10°C	1000 hr	1	0
	High Humidity Heat	60°C / RH=90%	1000 hr	1	0
Strength Test	Vibration	Acceleration	5G	1	0
		10-150Hz Scan Cycle	20 cycle		
		Scan Speed (XYZ Axis)	1 oct/min		

Block Diagram

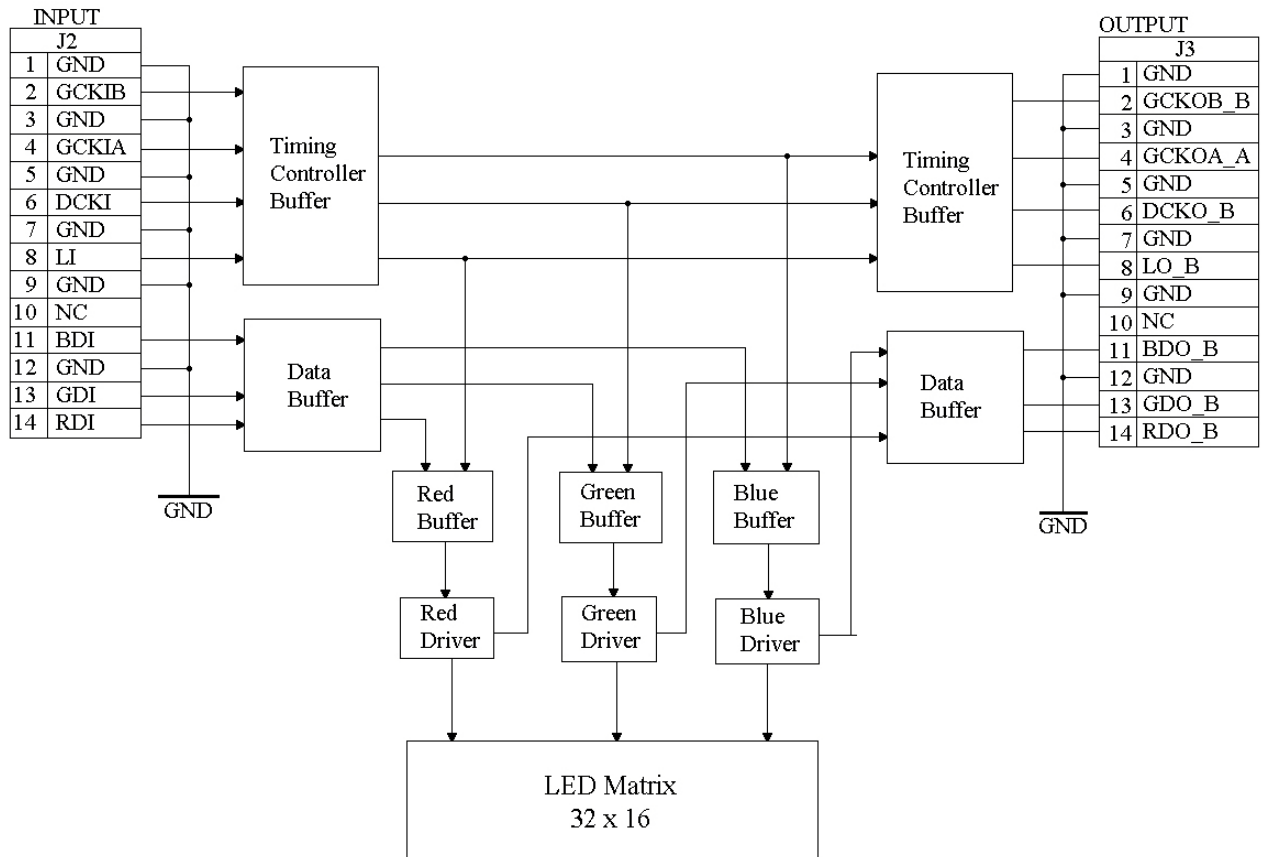

Interface Connection

Power I/F : 3047-12FN ALEX Connector Co., Ltd.

J1			
No.	Signal name	No.	Signal name
1	GND	7	VCC
2	GND	8	VCC
3	GND	9	VCC
4	GND	10	VCC
5	GND	11	VCC
6	GND	12	VCC

Input, Output I/F : C06S-14ASB1-G Don Connex Electronics Co., Ltd.

J2				J3			
No.	Signal name	No.	Signal name	No.	Signal name	No.	Signal name
1	GND	2	GCKIB	1	GND	2	GCKOB_B
3	GND	4	GCKIA	3	GND	4	GCKOA_B
5	GND	6	DCKI	5	GND	6	DCKO_B
7	GND	8	LI	7	GND	8	LO_B
9	GND	10	NC	9	GND	10	NC
11	BDI	12	GND	11	BDO_B	12	GND
13	GDI	14	RDI	13	GDO_B	14	RDO_B

Pin Function Description

Signal Name	Description	Signal Name	Description
VCC	Power Input for module	GND	Ground Connection
NC	Not Use		
LI	Data Latch(LE) Input	LO_B	Data Latch(LE) Output
DCKI	Data Clock value Input	DCKO	Data Clock value Output
GCKIA	Gray Scale Clock Input Red & Green	GCKOA_B	Gray Scale Clock Output Red & Green
GCKIB	Gray Scale Clock Input Blue	GCKOB_B	Gray Scale Clock Output Blue
RDI	Red Data Input	RDO_B	Red Data Input
GDI	Green Data Input	RDO_B	Green Data Input
BDI	Blue Data Input	RDO_B	Blue Data Input

Driver IC Terminal Configuration

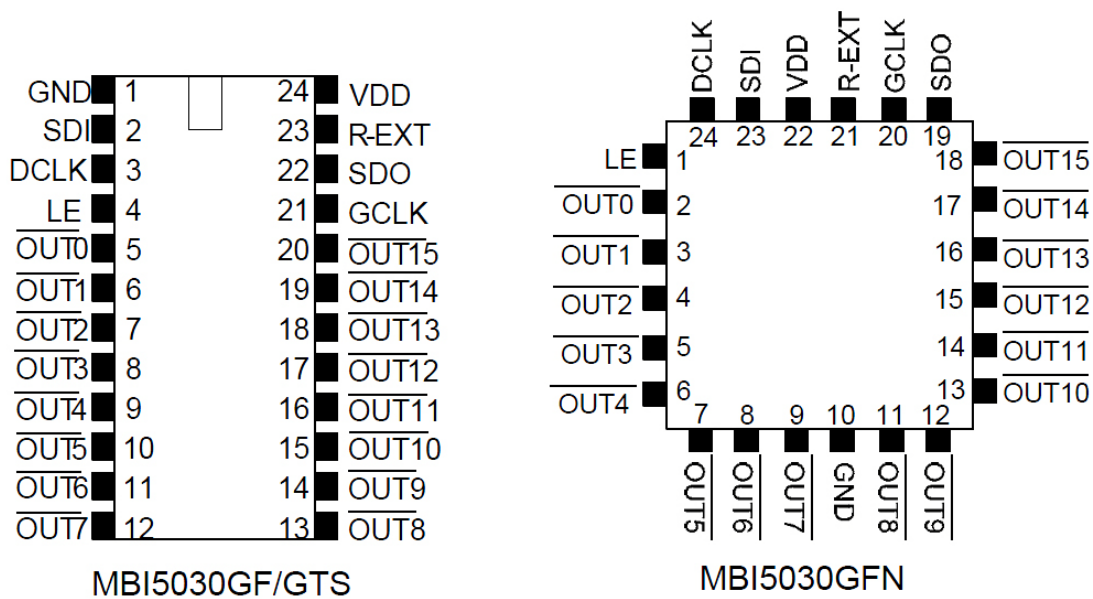

Pin Name	Function	Module Pin
GND	Ground terminal for control logic and current sink	
SDI	Serial-data input to the shift register	RDI GDI BDI ERDI
DCLK	Clock input terminal used to shift data on rising edge and carries command information when LE is asserted.	DCLKI
LE	Data strobe terminal and controlling command with DCLK	LI
Out0 – Out15	Constant current output terminals	
GCLK	Gray scale terminal Clock input for gray scale. The gray scale display is counted by gray scale clock comparing with input data.	GCLKIA GCLKIB
SDO	Serial-data output to the receiver-end SDI of next driver IC	RDO_B GDO_B BDI_B ERDO_B
R-EXT	Input terminal used to connect an external resistor for setting up output current for all output channels	
VDD	3.3V / 5V supply voltage terminal	VCC

Switch Characteristics

Characteristics		Min	Typ.	Max	Unit
Setup Time	SDI - DCLK(H)	1			ns
	LE(H) - DCLK(H)	1			ns
	LE(L) - DCLK(H)	5			ns
Hold Time	DCLK(H) - SDI	3			ns
	DCLK(H) - LE(L)	7			ns
Pulse Width	LE	5			ns
	DCLK	15			ns
	GCLK	15			ns
Output Rise Time of Output Ports		15	25		ns
Output Fall Time of Output Ports		10	15		ns
Data Clock Frequency				30	MHz
Gray Scale Clock Frequency				33	MHz

Timing Waveform

(1)

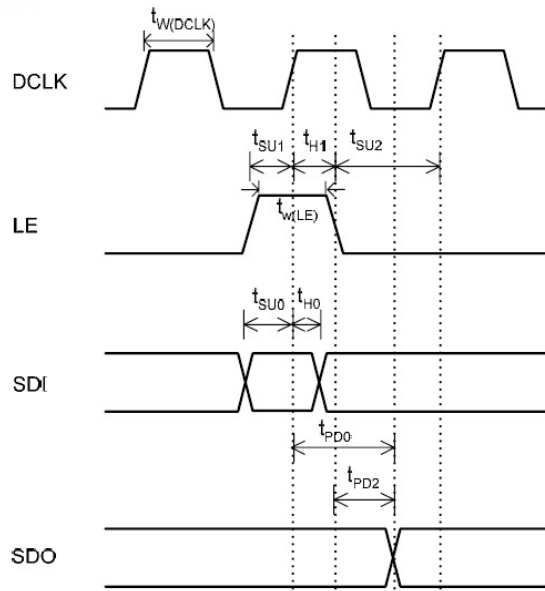

(2)

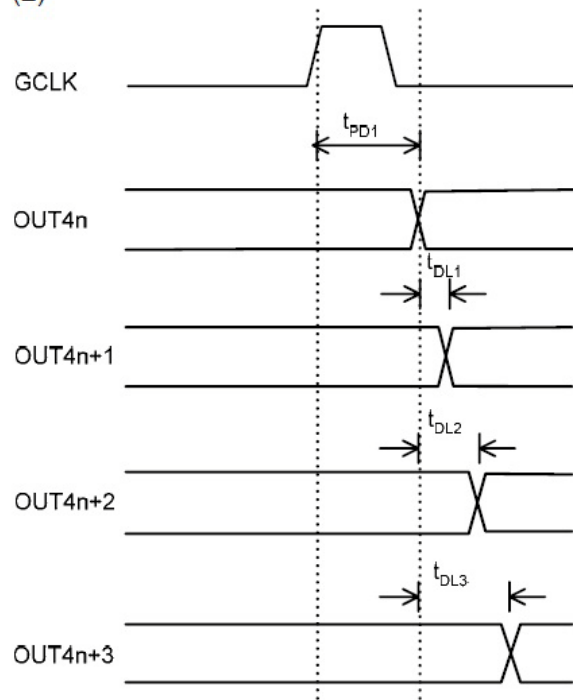

Timing Chat

Data Latch

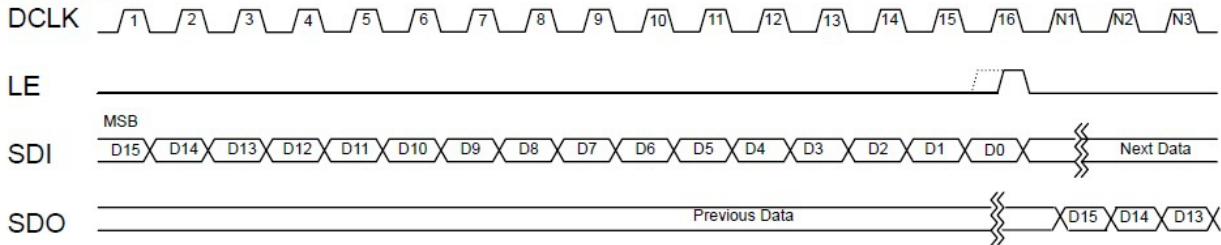

Global Latch

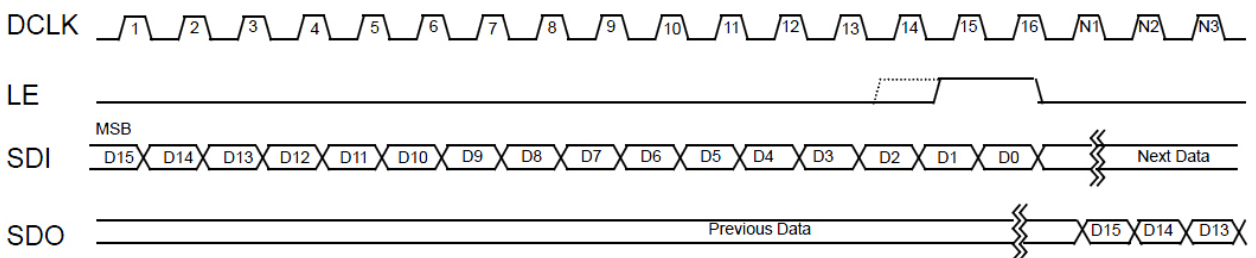

Read Configuration

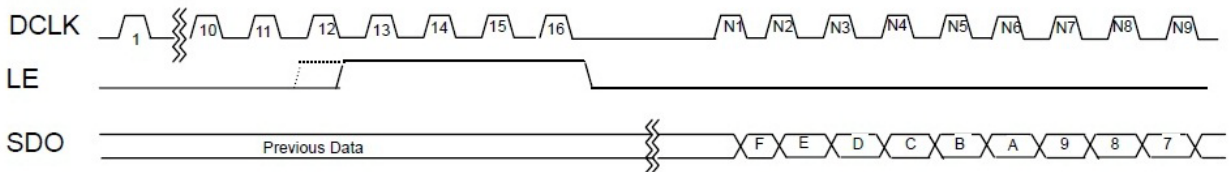

Write Configuration

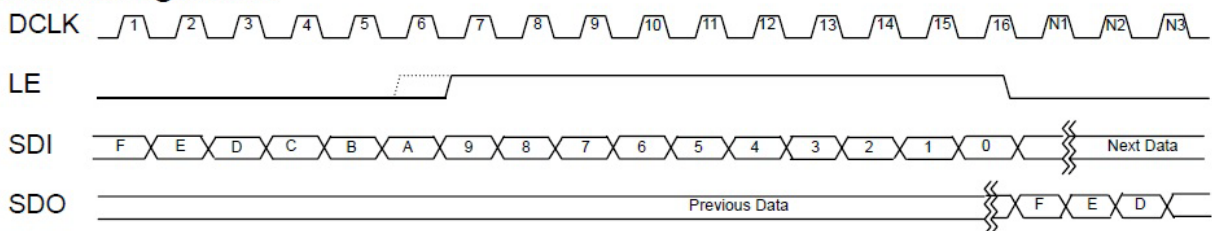

Full Timing for Data Loading

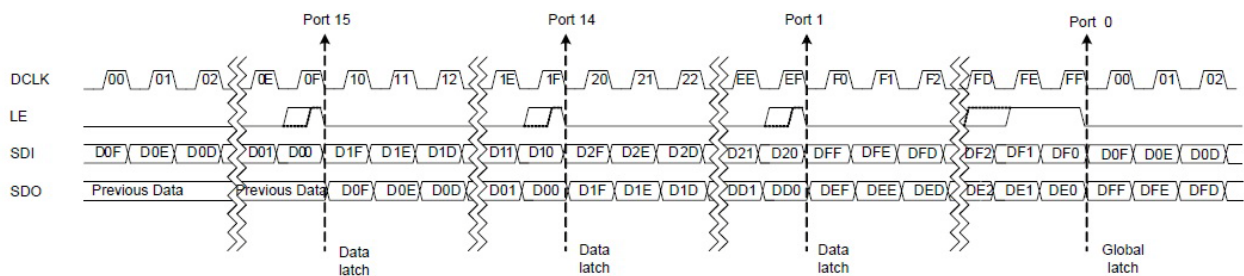

LED Mapping

1	2	9	10	17	18	25	26	33	34	41	42	49	50	57	58	257	258	265	266	273	274	281	282	289	290	297	298	305	306	313	314
3	4	11	12	19	20	27	28	35	36	43	44	51	52	59	60	259	260	267	268	275	276	283	284	291	292	299	300	307	308	315	316
5	6	13	14	21	22	29	30	37	37	45	46	53	54	61	62	261	262	269	270	277	278	285	286	293	294	301	302	309	310	317	318
7	8	15	16	23	24	31	32	39	40	47	48	55	56	63	64	263	264	271	272	279	280	287	288	295	296	303	304	311	312	319	320
65	66	73	74	81	82	89	90	97	98	105	106	113	114	121	122	321	322	329	330	337	338	345	346	353	354	361	362	369	370	377	378
67	68	75	76	83	84	91	92	99	100	107	108	115	116	123	124	323	324	331	332	339	340	347	348	355	356	363	364	371	372	379	380
69	70	77	78	85	86	93	94	101	102	109	110	117	118	125	126	325	326	333	334	341	342	349	350	357	358	365	366	373	374	381	382
71	72	79	80	87	88	95	96	103	104	111	112	119	120	127	128	327	328	335	336	343	344	351	352	359	360	367	368	375	376	383	384
129	130	137	138	145	146	153	154	161	162	169	170	177	178	185	186	385	386	393	394	401	402	409	410	417	418	425	426	433	434	441	442
131	132	139	140	147	148	155	156	163	164	171	172	179	180	187	188	387	388	395	396	403	404	411	412	419	420	427	428	435	436	443	444
133	134	141	142	149	150	157	158	165	166	173	174	181	182	189	190	389	390	397	398	405	406	413	414	421	422	429	430	437	438	445	446
135	136	143	144	151	152	159	160	167	168	175	176	183	184	191	192	391	392	399	400	407	408	415	416	423	424	431	432	439	440	447	448
193	194	201	202	209	210	217	218	225	226	233	234	241	242	249	250	449	450	457	458	465	466	473	474	481	482	489	490	497	498	505	506
195	196	203	204	211	212	219	220	227	228	235	236	243	244	251	252	451	452	459	460	467	468	475	476	483	484	491	492	499	500	507	508
197	198	205	206	213	214	221	222	229	230	237	238	245	246	253	254	453	454	461	462	469	470	477	478	485	486	493	494	501	502	509	510
96	200	207	208	215	216	223	224	231	232	239	240	247	248	255	256	455	456	463	464	471	472	479	480	487	488	495	496	503	504	511	512

Shift Register Mapping

LED															
1	2	3	4	5	6	7	8	9	10	11	12	13	14	15	16
1	2	3	4	5	6	7	8	9	10	11	12	13	14	15	16
17	18	19	20	21	22	23	24	25	26	27	28	29	30	31	32
33	34	35	36	37	38	39	40	41	42	43	44	45	46	47	48
49	50	51	52	53	54	55	56	57	58	59	60	61	62	63	64
65	66	67	68	69	70	71	72	73	74	75	76	77	78	79	80
81	82	83	84	85	86	87	88	89	90	91	92	93	94	95	96
97	98	99	100	101	102	103	104	105	106	107	108	109	110	111	112
113	114	115	116	117	118	119	120	121	122	123	124	125	126	127	128
129	130	131	132	133	134	135	136	137	138	139	140	141	142	143	144
145	146	147	148	149	150	151	152	153	154	155	156	157	158	159	160
161	162	163	164	165	166	167	168	169	170	171	172	173	174	175	176
177	178	179	180	181	182	183	184	185	186	187	188	189	190	191	192
193	194	195	196	197	198	199	200	201	202	203	204	205	206	207	208
209	210	211	212	213	214	215	216	217	218	219	220	221	222	223	224
225	226	227	228	229	230	231	232	233	234	235	236	237	238	239	240
241	242	243	244	245	246	247	248	249	250	251	252	253	254	255	256
257	258	259	260	261	262	263	264	265	266	267	268	269	270	271	272
273	274	275	276	277	278	279	280	281	282	283	284	285	286	287	288
289	290	291	292	293	294	295	296	297	298	299	300	301	302	303	304
305	306	307	308	309	310	311	312	313	314	315	316	317	318	319	320
321	322	323	324	325	326	327	328	329	330	331	332	333	334	335	336
337	338	339	340	341	342	343	344	345	346	347	348	349	350	351	352
353	354	355	356	357	358	359	360	361	362	363	364	365	366	367	368
369	370	371	372	373	374	375	376	377	378	379	380	381	382	383	384
385	386	387	388	389	390	391	392	393	394	395	396	397	398	399	400
401	402	403	404	405	406	407	408	409	410	411	412	413	414	415	416
417	418	419	420	421	422	423	424	425	426	427	428	429	430	431	432
433	434	435	436	437	438	439	440	441	442	443	444	445	446	447	448
449	450	451	452	453	454	455	456	457	458	459	460	461	462	463	464
465	466	467	468	469	470	471	472	473	474	475	476	477	478	479	480
481	482	483	484	485	486	487	488	489	490	491	492	493	494	495	496
497	498	499	500	501	502	503	504	505	506	507	508	509	510	511	512

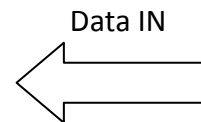

Module dimension

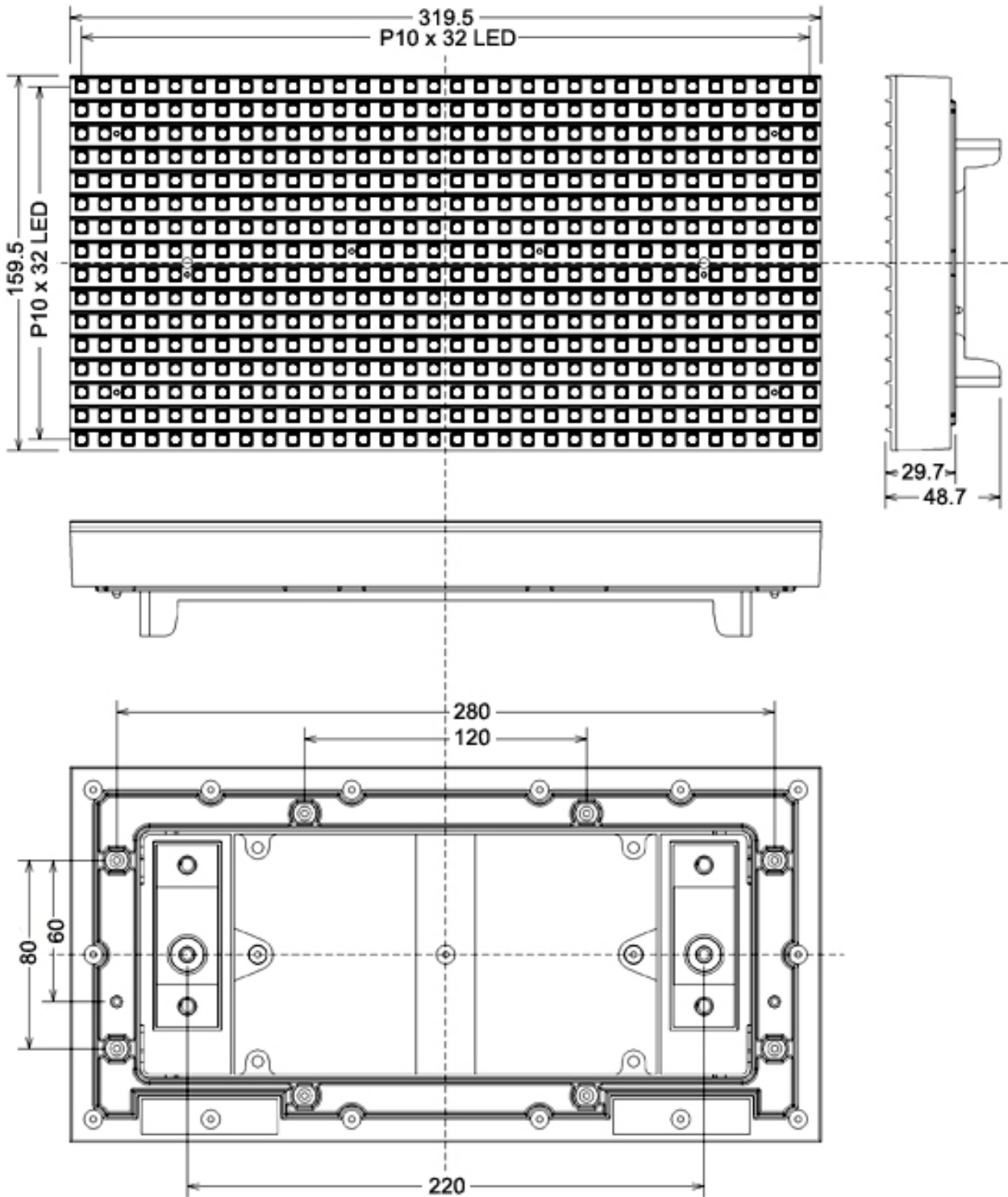

Important Notice

Information of this document

1. Sander Electronics reserves the right to make changes, corrections, modifications, and improvements on our products and documents, or to discontinue any product or service without further notice. Customers are advised to consult our sales representatives for the latest product information before placing orders. All sold products are subject to the terms and conditions supplied at the time of order acknowledgment, including those pertaining to warranty, patent infringement, and limitation of liability.
2. Related technologies applied to the product are protected by patents. All text, images, logos and information contained on this document are the intellectual property of Sander Electronics. Unauthorized reproduction, duplication, extraction, use or disclosure of the above mentioned intellectual property will be deemed as infringement.

Safety Precautions

1. The products are designed and produced for application of ordinary electronic equipment (AV, office, telecommunication, home appliances, amusement, etc)
If the product to be used in devices requiring extremely high reliability such as medical, transport, aircraft/spacecraft, nuclear power controllers, fuel controllers, car equipment including car accessories, safety devices, etc., the malfunction of this product may result in any serious damages (against human life, human body, etc.), please consider of fail-safe design absolutely and secure safety as below
 - a) Installation of protection circuits or other protective devices to improve system-safety.
 - b) Installation of redundant circuits in order to avoid risks by single-circuit failure
2. The product are designed for use of ordinary electronic equipment such as displaying letters and video images, and not designed for uses in the following special environments.
 - a) Use in various types of liquid, including water, oils, chemicals, and organic solvents.
 - b) Use in place where the products are exposed to sea winds or corrosive gases
 - c) Use in places where the products are exposed to static electricity or electromagnetic waves.
 - d) Use in proximity to heat-producing components, plastic cords, or other flammable items.
 - e) Use of the products in dew condensation.
3. The products are not resistant to radiation.
4. SANDER does not responsible for any problems resulting from the uses of the products against this specification
5. SANDER should be notified of any product-safety issues. Moreover, product safety issues should be periodically monitored by the customer.
6. The features of this product are high brightness and multicolored emission; however, this product may have a bad effect on human eyes. In case of looking at this products at close range for a long time, we highly recommend using an eye protection for UV cut and light reduction.

Important Notice

7. There are some high-temperature parts inside the products. Please do not touch the parts directly. Moreover, please do not put any flammable substances close to the parts due to ignition.
8. Please do not put over-voltage against the absolute voltage as it may cause failure of products.

Prohibitions Regarding Industrial Property

1. These Specifications contain information related to SANDER's industrial property. Any uses besides the usage of these products are not permitted. Duplication of these specifications and its disclosure to the third party without permission from SANDER are prohibited.
2. Information and data on the products written in this specification are examples. This specification does not guarantee that there is no infringement against intellectual property rights of the third party and any other rights. Therefore, SANDER does not have any responsibility such as following condition;
 - a) Infringement of the intellectual property rights of the third party
 - b) Any problems incurred by the use of the products listed herein.
3. SANDER prohibits the purchaser of its products to exercise or use the intellectual property rights, industrial property rights, or any other rights that either belong to or are controlled by SANDER, other than the right to use, sell, or dispose of the products.

Precautions on Use of Products.

1. LEDs and parts, are very weak against external impact. LEDs and Parts may be damaged due to contact of tools or your casing of the products to the products. When handling the products, please pay special attention.
2. The products are not designed to tolerate against solvent. Please pay special attention not to attach any organic solvent such as thinner, to the products.
3. The products apply high density LSIs that are very weak to static electricity. While handling the products, please wearing an earth band to make human body electrification lower than 100V. Especially, cloths made by chemical fiber are likely to be electrified several thousand voltages of static electricity and it may destroy the circuits.
4. Please wear clean gloves when handling the products as sweat or sebum attached with hands may corrode the products and it may cause the breakdown.
5. When detaching connectors, please make sure SANDER products are firmly attached with your products, supply voltage is switched off and no remaining voltage. Also please do not detach connectors when power-supply is on as it may damage the products. Please be careful not to miss-insert connectors.
6. Once products are exposed to UV rays for long time, the colors of LED and PCB/Housing may change the color.
7. Please do not touch the edges with module or metals as a part of circuit patterns may be exposed around the PCBs.
8. In case looking the products through sunglasses or finder of camera, the color would be different as you sense by looking by eyes, and an accurate evaluation may be difficult to be made.

Important Notice

When using power supply not applies or approved by SANDER

1. Surge voltage / current flow will damage the product, user should measured and make sure the power supply will not supply power over absolute specification.
2. In case of using switching power supply for constant voltage power supply, linking-noise may occur and in the image displayed on the products, noise could be mixed or inhomogeneity of brightness and color tone could occur.
3. The products require VCC power supply for control and LED for lighting. The system GND potential-point should be a part of power supply connectors to prevent multiple-point earth of duplicate connection as each GND is connected near the connectors of the products.
4. The installation of the products, in case falling screws and they hit the parts of circuits, the products could be damaged.

When Casing the product by use items not provide by SANDER

1. Please make sure of designing the casing with sufficient margin of safety by taking into consideration ofr the heat generation and the thermal expansion, especially when using various units interconnected each other.
2. Please use as short signal lines as possible. (MHz units's frequency signal had transmission distance limit)
3. Please take special care for heat dissipation using fan etc. As internal heat may cause luminous intensity down or extra ordinal operation. Please also pay attention to inhomogeneity due to heat dissipation.
4. These products include digital circuits and induce high-frequency noise. it is a possibility to give some disturbance to other surrounding equipments depending on the way to wire or the way of assemble chassis.
When connecting with other units, signal lines will be wired around and noise will be radiated, please design the chassis by fully considering of signal frequency and EMI ability if necessary.

Activity Condition

1. The shapes of dots covering over LED dies are different from each other somehow, therefore, while condition of non-lighting may see some pattern
2. The aging characteristics of LED may given luminous intensity differ between frequent and infrequent lighting areas. Difference will be more obvious at fixed emitting area.
3. The brightness of LED become dimming once unit's temperature increases. Please note that the brightness may vary depending on the lighting rate and lighting time per product.

Important Notice

Guarantee

1. Sander Electronics will not be held liable for any damages or claims resulting from the use of its products in medical and military applications.
2. The guaranteed period of luminous intensity and product performance is within one year from shipment by SANDER, with recommended storage conditions and product are not opened.
(SANDER Recommended Storage Condition : $25^{\circ}\text{C} \pm 10^{\circ}\text{C}$; $\text{RH} = 50\% \pm 10\%$)
3. Even during guarantee period, request of repair base on following situation require charge of fee
 - a) Accident due to careless handling and unexpected usage.
 - b) Accident due to repairs or improvements without permission of SANDER
 - c) Accident due to uncontrollable situation (Fire, flood, disaster, war, etc.)

Revision History

Datasheet Version	Modification Data	Modifier
V2.11	2012 / 3 / 15	Jay
V3.0	2012 / 3 / 16	Jay